

Parts Manual

for PG160, PG225 & PG300



Manufacturer of Quality Power Sprayers
P.O. Box 3107
Visalia, CA 93278-3107 • USA
(559)SDI-5555 / Fax (559)SDI-5591
www.sprayingdevices.com

Parts Illustration

PG160U/PG225U/PG300U

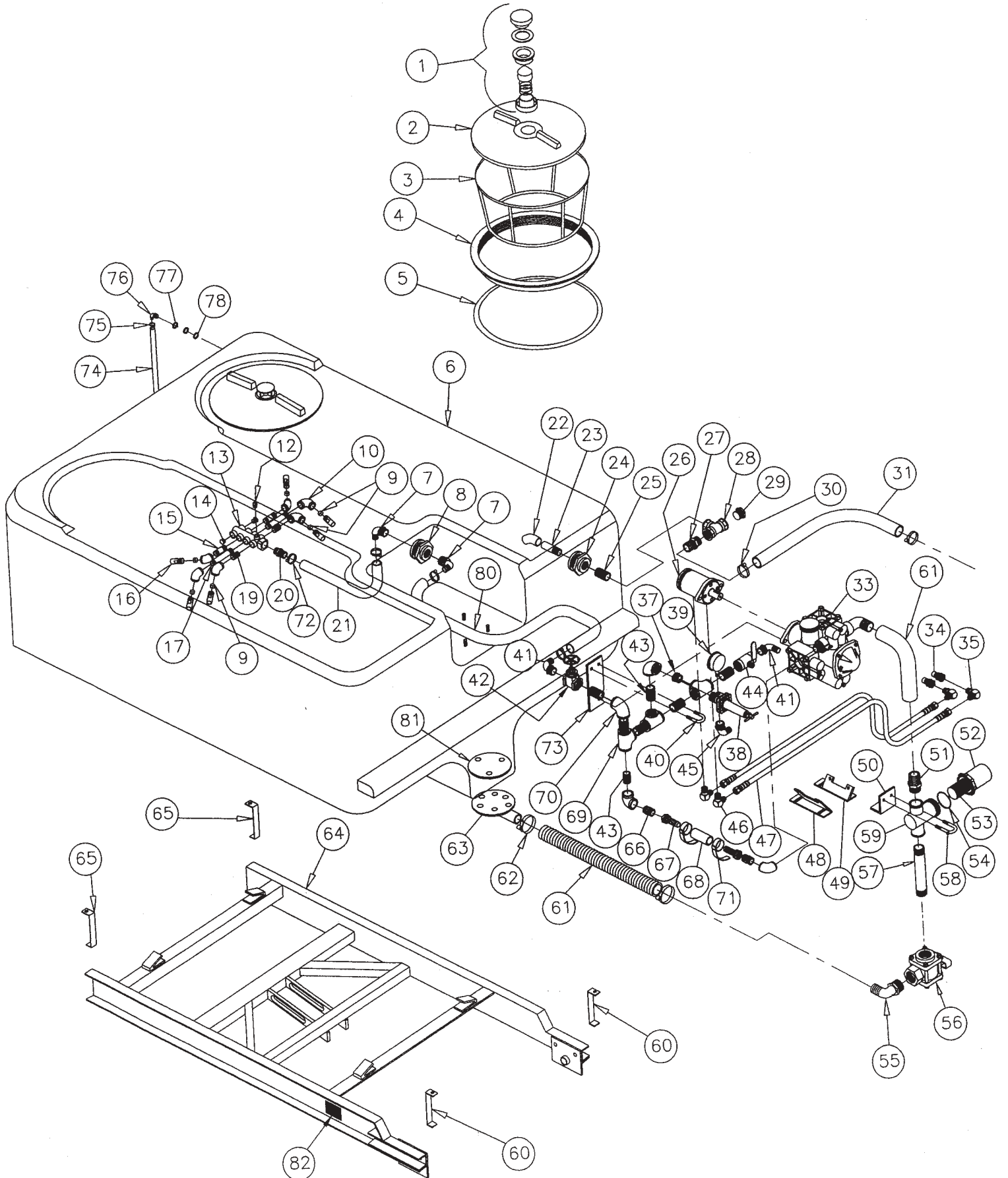

Parts Illustration

PG160ABU/PG225ABU/PG300ABU

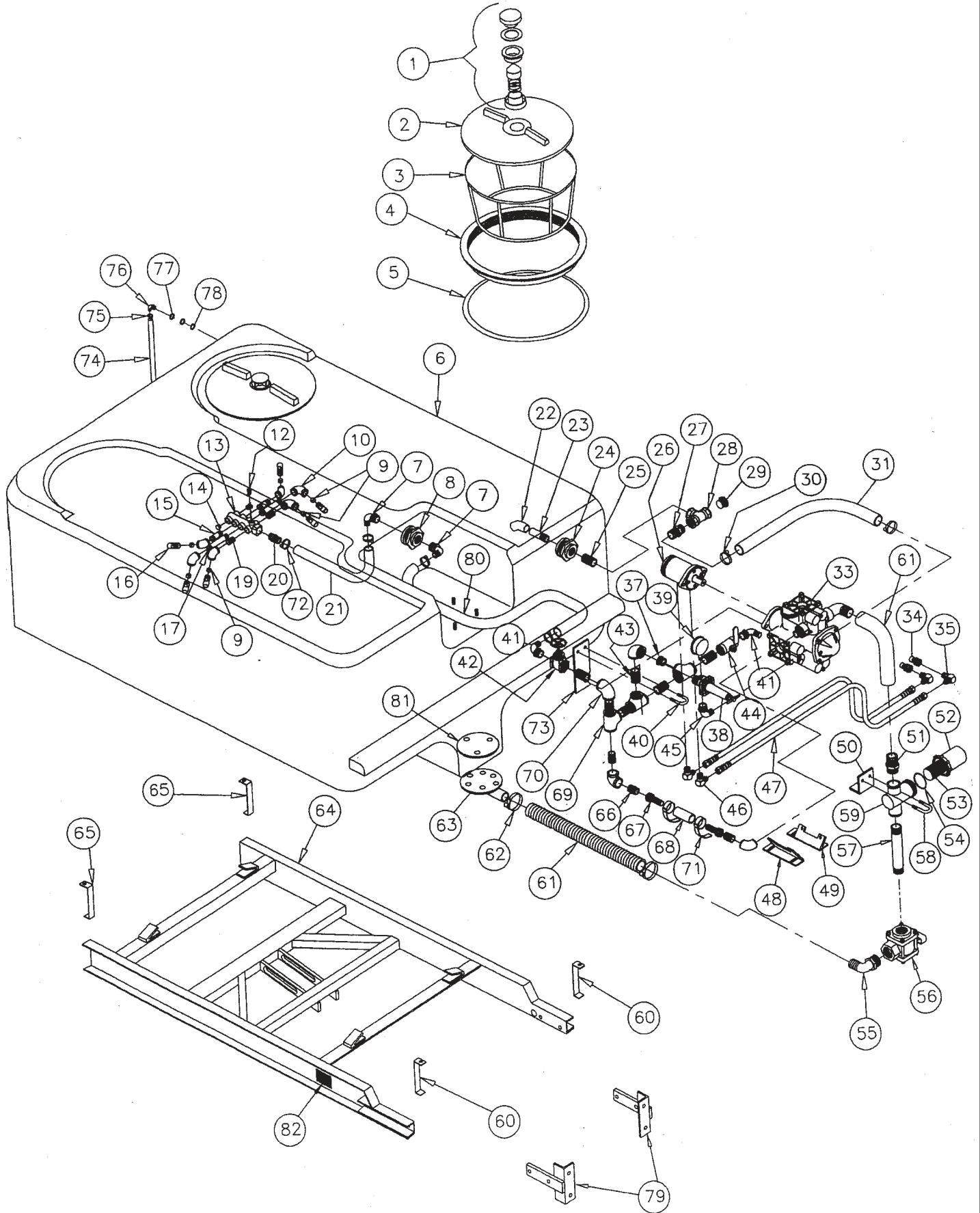

Parts List

<u>Item No.</u>	<u>Part No.</u>	<u>Description</u>	<u>Qty</u>
1	15-056	Vent Assembly	1
2	15-053	16" Lid	1
3	16-203	16" Strainer Basket	1
4	15-054	16" Rim	1
5	15-055	C-Gasket	1
6	15-169SG	Tank 160 Gallon	1
6	15-229SG	Tank, 225 Gallon	1
6	15-329SG	Tank, 300 Gallon	1
7	52-112	Elbow Adapter 3/4 MPT x 3/4" HB	2
8	16-115	Tank Fitting 3/4" DT Nylon	1
9	64-585	Spray Tip DCER5	4
10	50-413SS	Elbow 1/2" SST 45°	6
11	64-587	Spray Tip DCER7	2
12	50-280SS	Plug 1/4" SST	1
13	16-087	Manifold	1
14	53-884	Plug 1/2" PVC	2
15	53-897	Pipe Nipple 1/2 x 2" Poly	2
16	16-050	Jet Agitator	6
17	53-899	Pipe Nipple 1/2 x 4" Poly	2
18	24-110	Hose Clamp #10	2
19	53-901	Close Nipple 1/2" PVC	2
20	53-134	Adapter 3/4 MPT x 3/4" HB	1
21	21-930	Hose 3/4" ID 200 PSI, Per Foot	Specify
22	52-276	Elbow 1" x 45° PC	1
23	53-204	Nipple 1 x 4" PVC (Cut to 2")	1
24	16-117	Tank Fitting 1" DT Nylon	1
25	53-912	Close Nipple 1" PVC	1
26	20-050	Hydraulic Motor	1
27	53-435	Adapter 1 MPT x 1" HB	1
28	53-826	Tee 1" Poly	1
29	53-886	Pipe Plug 1" Poly	1
30	24-116	Hose Clamp #16	2
31	21-933	Hose 1-1/2" ID, 200 PSI, Per Foot	Specify
33	78-0030	Pump W/Flange 31GPM, 200 PSI	1
34	52-394	Hydraulic Nipple	2
35	50-030	Elbow	2
37	50-580SS	Pipe Plug 3/4" SST	1
38	64-805	Relief Valve (Parts Breakdown on Page 5)	1
39	27-300	Pressure Gauge 0-300 PSI	1
40	47-103	U-bolt 1/4 x 1-1/4 x 2-1/4"	1
41	52-112	Elbow Adapter 3/4 MPT x 3/4" HB	2
42	60-203	Gate Valve 3/4"	1
43	51-501SS	Close Nipple 3/4" SST	7
44	60-324	Ball Valve 3/4"	1

Parts List

<u>Item No.</u>	<u>Part No.</u>	<u>Description</u>	<u>Qty</u>
45	52-114	Elbow Adapter 3/4 MPT x 1" HB	1
46	50-030	Elbow 1/2 MPT x 1/2" MJIC	2
47	Hydraulic Hose Assembly - <i>must be pre-assembled at factory and includes the following:</i>		
	50-032	Hydraulic Fitting 1/2"	2
	21-040	Hydraulic Hose 1/2" Per Foot	Specify
48	11-420L	Left Pump Mount	1
49	11-420R	Right Pump Mount	1
50	11-462	Suction Basket	1
51	53-445	Adapter 1-1/2 MPT x 1-1/2" HB	1
52	57-117S	Solid Bowl	1
53	57-152	20 Mesh Screen	1
54	57-116	O-ring	1
55	52-128	Elbow Adapter 1-1/2 MPT x 1-1/2" HB	1
56	60-327-3PP	3-Way Valve 1-1/2" Bottom Load	1
57	53-940	Pipe Nipple 1-1/2 x 10" Poly	1
58	47-207	U-bolt 3/8 x 1-1/2 x 3-1/4"	1
59	57-151	Body for Strainer	1
60	11-394	Rear Tank Strap	2
61	21-933	Suction Hose 1-1/2" ID, Per Foot	Specify
62	24-124	Hose Clamp #24	4
63	17-131	Suction Flange 1-1/2"	1
64	10-229	Frame	1
64	10-229AB	Frame for ABU Models	1
65	11-431	Front Tank Strap	2
66	55-106	Adapter 3/4 MPT x 3/4" MGHT	2
67	55-311	Hose Coupler 3/4 FGHT x 3/4" HB	2
68	81-750	Hose 3/4" ID, 800 PSI, Per Foot	Specify
69	50-520SS	Tee 3/4" SST	3
70	50-511SS	Elbow 3/4" SST	4
71	24-204	Hose Clamp JS204	2
72	24-112SS	Hose Clamp #12 SST	2
73	11-440	Relief Valve Bracket/9910-D115 Pump	1
74	16-922	Clear Tubing 3/8" ID, Per Inch	Specify
75	24-104	Hose Clamp #4	2
76	16-100	Elbow Adapter 3/8 MPT x 3/8" HB	2
77	55-050	Rubber Washer 3/4"	4
78	55-052	Nylon Washer 3/4"	2
79	11-768AB	Boom Mount Brackets <i>for ABU Models Only</i>	2
80	21-930	Hose 3/4" ID 150 PSI, Per Foot	Specify
81	11-101	Vortex Baffle	1
82	70-357	Serial and Model Number Decal	1

Parts Illustration and Parts List

64-805 Relief Valve

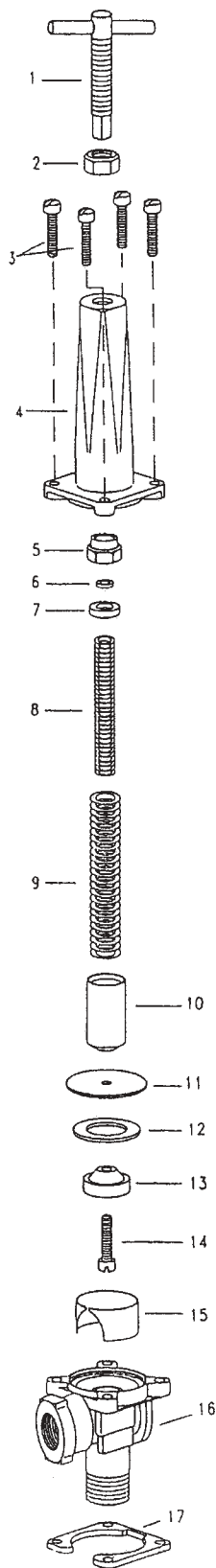

<u>Item No.</u>	<u>Part No.:</u>	<u>Description</u>	<u>Qty</u>
1	64-820	Adjusting Stem Subassembly Aluminum and SST	1
2	64-821	Lock Nut, Aluminum	1
3	64-822	Steel Screw, Zinc Plated	4
4	64-823	Bonnet, Aluminum	1
5	64-824	Adjusting Nut, SST	1
6	64-825	Nylon Washer, Black	1
7	64-826	Spring Retainer, Aluminum	1
8	64-827	Inside Spring	1
9	64-828	Outside Spring, Steel	1
10	64-829	Guide Sleeve, Aluminum	1
11	64-830	Diaphragm, Fairprene	1
12	64-831	Stop Ring Type 304 SST	1
13	64-832	Back Up Seat, Black Nylon	1
14	64-833	Screw, SST	1
15	64-834	Chamber Insert, SST	1
16	64-835	Nylon Body, Black	1
17	64-836	Clamp Plate, Steel	1
	64-840	Repair Kit, Includes Items 6, 8, 9, 11 and 13	

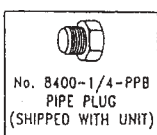



Form No. 1922.0210jh